

SILENZIATORE

modello
EP/EP
METALLIC

Livelli di rumore in dB 6 BAR Noise level at 6 BAR

1/8	1/4	3/8	1/2	3/4	1
83	83	83	84	84	81

Livelli di rumore in dB 4 BAR Noise level at 4 BAR

1/8	1/4	3/8	1/2	3/4	1
77	77	77	79	79	80

A	B	C	D	E
1/8" BSP	49	80	70	10
1/4" BSP	49	106	93	13
3/8" BSP	70	126	113	16
1/2" BSP	86	146	132	13
3/4" BSP	89	179	162	17
1 BSP	103	219	192	26
1"1/4" BSP	103	219	192	26
1"1/2" BSP	136	351	318	33
2 BSP	136	484	450	33

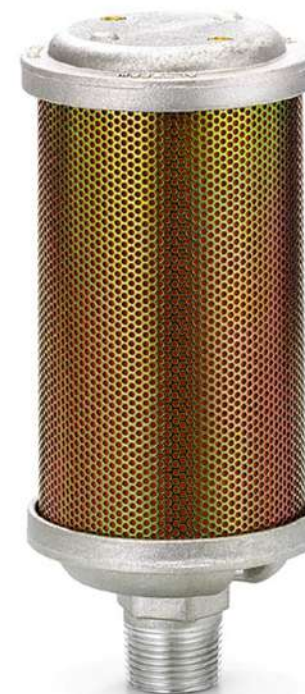
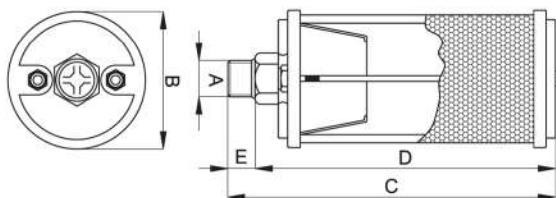

EP Max pressure 15 BARS
EPS Max pressure 42 BARS

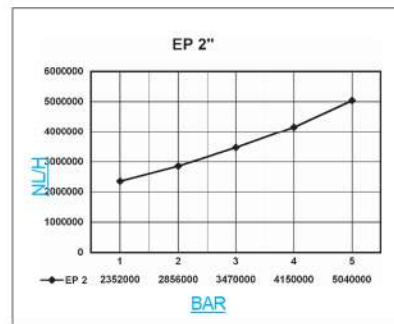
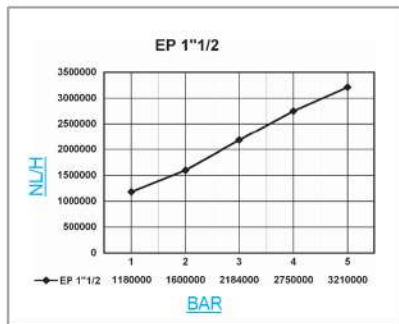
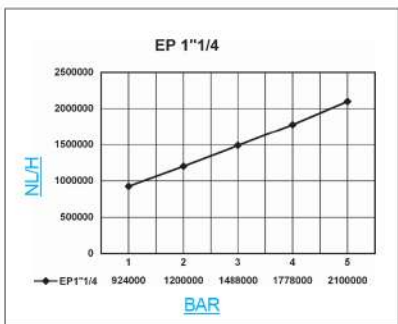
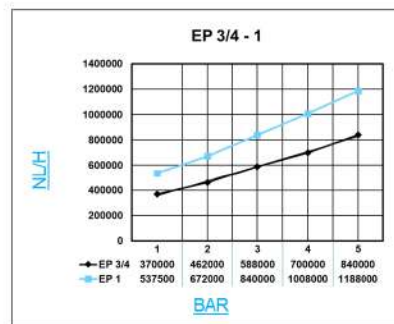
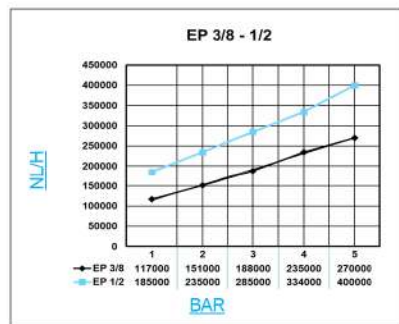
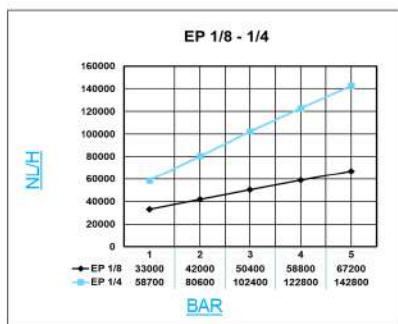

SILENZIATORI
AIR SILENCERS
SILENCIEUX
SCHALLDÄMPFER
COPOR



Condizioni normali di utilizzo dei silenziatori metallici sinterizzati: Temperatura massima: +80 °C - minima: -10 °C - Filettature speciali sono disponibili a richiesta per quantità. - Le caratteristiche e le dimensioni riportate nel presente catalogo non si intendono impegnative.
Maximum temperature: +80 °C - Lowest temperature: -10 °C - Characteristics and dimensions reported on this catalogue aren't engaging.

SILENZIATORE

modello
EP/EPS
METALLIC

Portata 6 BAR litri/minuto Payload 6,2 BAR liter/minute		
3"	4"	6"
2 x 10 ⁵	4 x 10 ⁵	1 x 10 ⁶

A	B	C	D	E	F
EP 3"	179	623	421	56	219
EP 4"	205	623	563	60	248
EP 6"	288	815	732	83	348

Silenziatore ad alta capacità

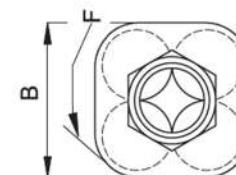
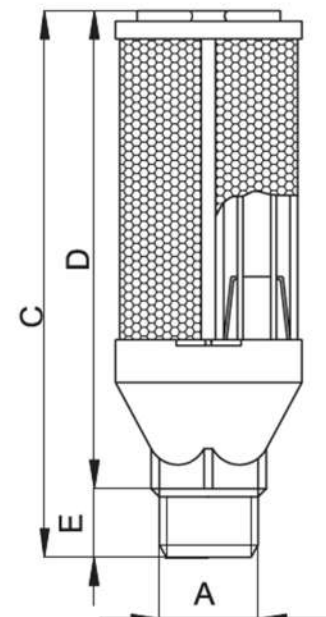

Per articoli da 3" a 6"
For articles from 3" to 6"

EP Max pressure 15 BARS
EPS Max pressure 42 BARS



28

SILENZIATORI
AIR SILENCERS
SILENCIEUX
SCHALLDÄMPFER
COPOR

